

0 601 345 603

Stand } ~~98-06~~  
Issue } 02-11-19

**Fig./Abb. 2**

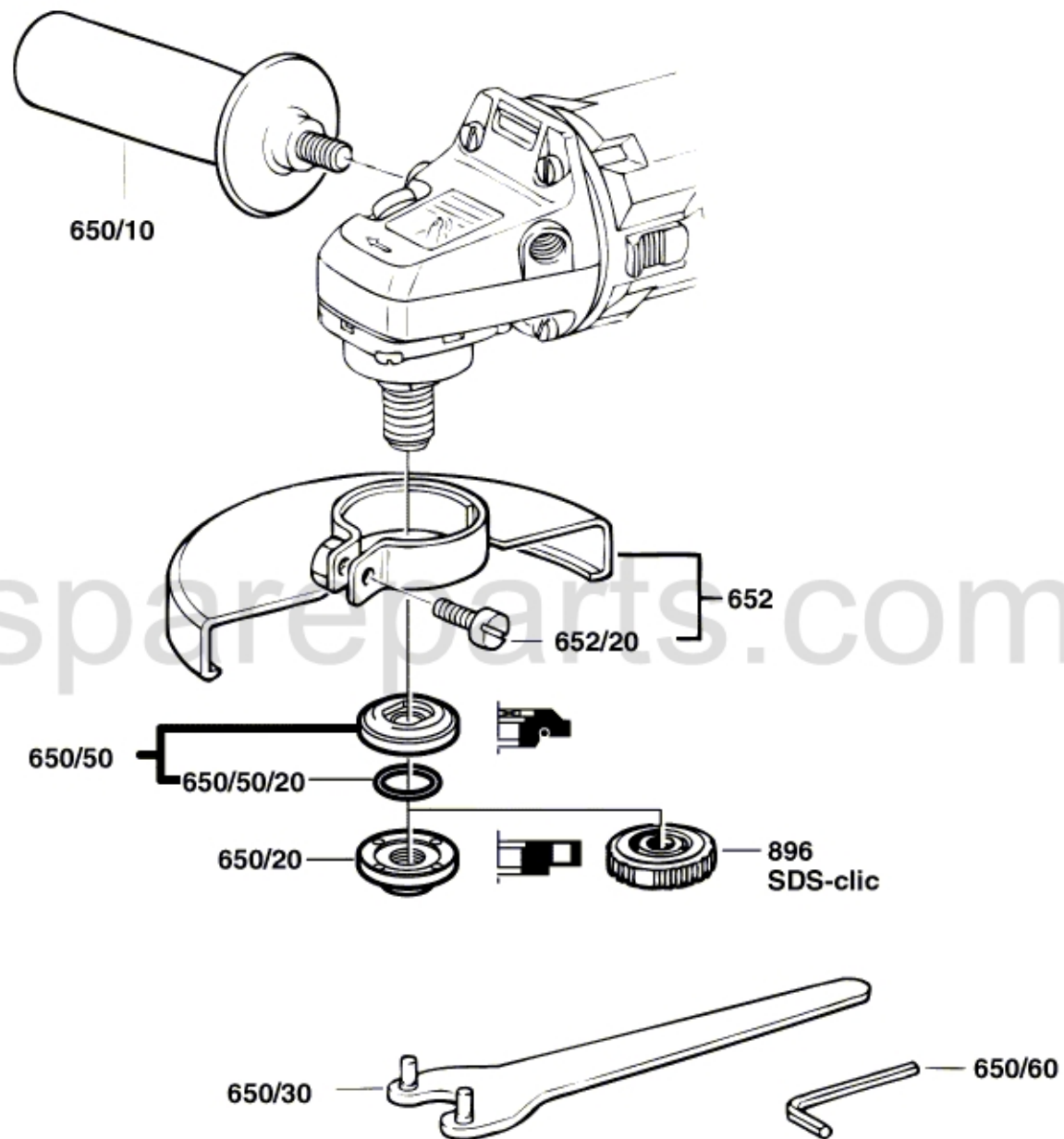

Änderungen vorbehalten  
Modifications reserved  
Modifications reserves  
Salvo modificaciones